

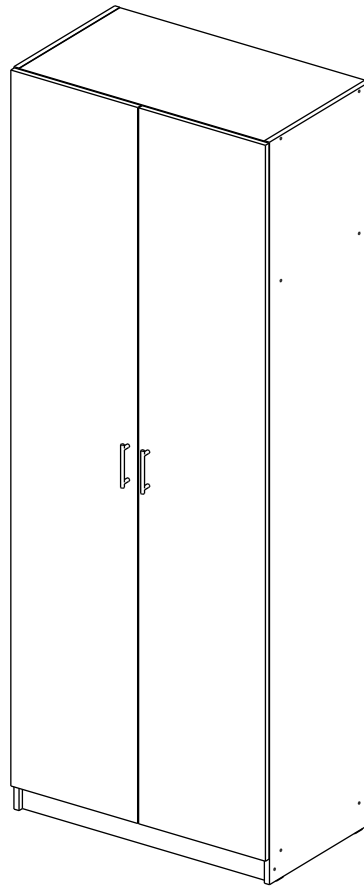

Фабрика меблів

**КИЇВСЬКИЙ СТАНДАРТ**



**ОФІСНИЙ  
ПЕНАЛ (№6)**

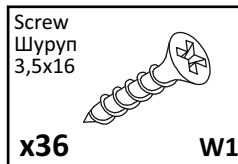
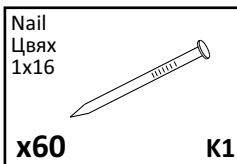
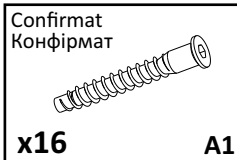
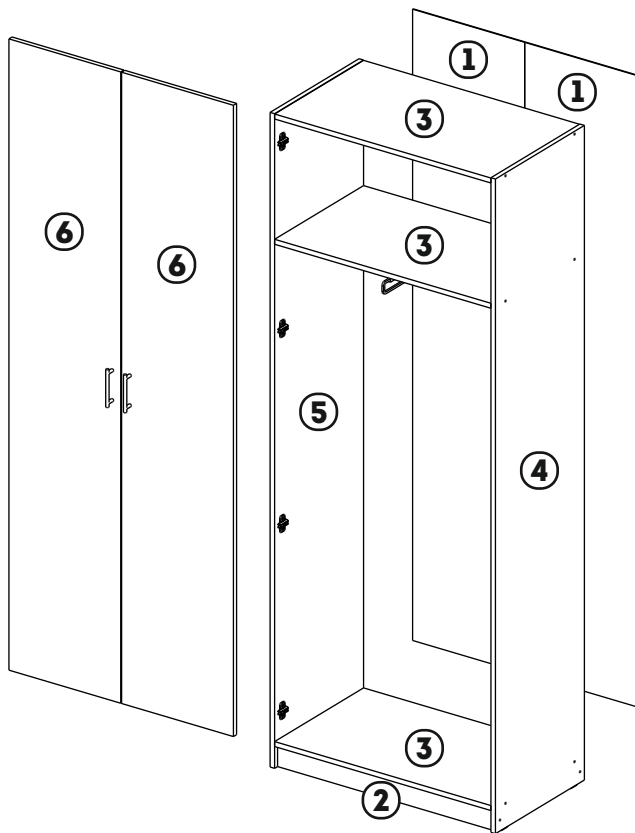

No	a*b	X
1	2026x398	2
2	768x70	2
3	768x451	3
4	2101x451	1
5	2101x451	1
6	2096x397	2

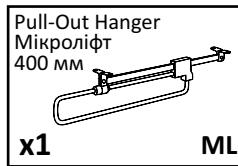



Фабрика меблів

**КИЇВСЬКИЙ СТАНДАРТ**

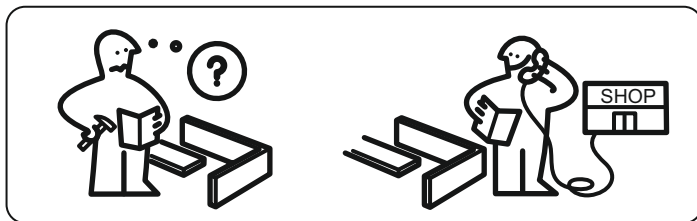
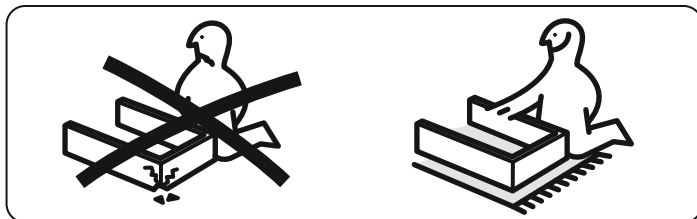
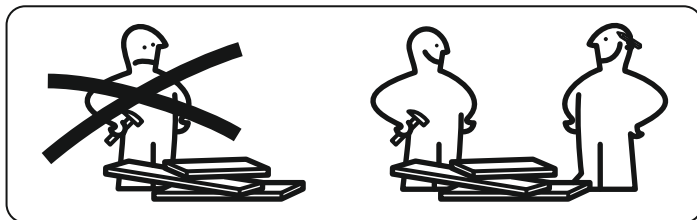

[kievstandart.com](http://kievstandart.com)

## ЗАГАЛЬНІ ТЕХНІЧНІ ВКАЗІВКИ ПО ЗБИРАННЮ МЕБЛІВ

- ПЕРЕД ЗБИРАННЯМ ПЕРЕВІРТЕ КОМПЛЕКТНІСТЬ ДЕТАЛЕЙ ТА ФУРНІТУРИ.
- ДЛЯ ЗБИРАННЯ МЕБЛІВ РЕКОМЕНДУЄМО СКОРИСТАТИСЬ ПОСЛУГАМИ КВАЛІФІКОВАНИХ СПЕЦІАЛІСТІВ.
- ДЛЯ ЗАПОБІГАННЯ ПОДРЯПИН ВИКОНУЙТЕ ЗБИРАННЯ НА ПОВЕРХНІ, ЯКА НАКРИТА ТКАНИНОЮ АБО КАРТОНОМ.

## ПРАВИЛА ДОГЛЯДУ ТА ЕКСПЛУАТАЦІЇ

- БЕРЕЖІТЬ МЕБЛІ ВІД ДОВГОГО КОНТАКТУ З ВОДОЮ ЧИ З ГАРЯЧОЮ ПАРОЮ.
- ЗАБЕЗПЕЧТЕ ДОСТАТНЮ ВІДСТАНЬ ВІД ЕЛЕКТРИЧНИХ ПРИЛАДІВ ТА ОБІГРІВАЧІВ.
- У РАЗІ ПОЯВИ БРУДУ НА МЕБЛЯХ ВИДАЛЯЙТЕ ЙОГО ВОЛОГОЮ ТКАНИНОЮ ІЗ НАСТУПНИМ ВИТИРАННЯМ НАСУХО. НЕ ВИКОРИСТОВУЙТЕ АБРАЗИВНІ МАТЕРІАЛИ.

## GENERAL TECHNICAL INSTRUCTIONS FOR FURNITURE ASSEMBLY

- CHECK COMPATIBILITY OF PARTS AND ACCESSORIES BEFORE ASSEMBLY.
- FOR FURNITURE ASSEMBLY, WE RECOMMEND USING THE SERVICES OF QUALIFIED SPECIALISTS.
- DO ASSEMBLY ON A SURFACE COVERED WITH CLOTH OR CARDBOARD TO PREVENT SCRATCHES.

## CARE AND MAINTENANCE OF FURNITURE

- KEEP THE FURNITURE FROM PROLONGED CONTACT WITH WATER OR HOT STEAM.
- ENSURE SUFFICIENT DISTANCE FROM ELECTRICAL APPLIANCES AND HEATERS.
- IF THERE IS DIRTY ON THE FURNITURE, REMOVE IT WITH A DAMP CLOTH AND THEN WIPE IT DRY. DO NOT USE ABRASIVE MATERIALS.

**1**

Mounting Plate  
Монтажная Планка

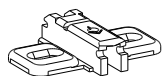
**x8****P6**

Screw  
Шуруп  
3,5x16

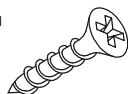
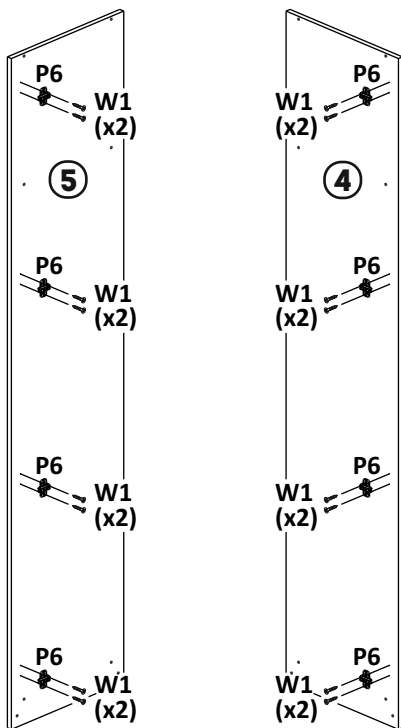
**x16****W1****2**

Confirmat  
Конфирмат

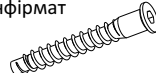
**x16****A1**

Cap for confirmate  
Заглушки для конфирмата

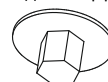
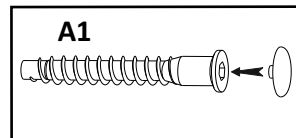
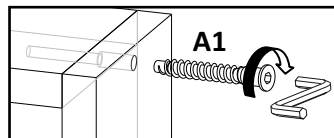
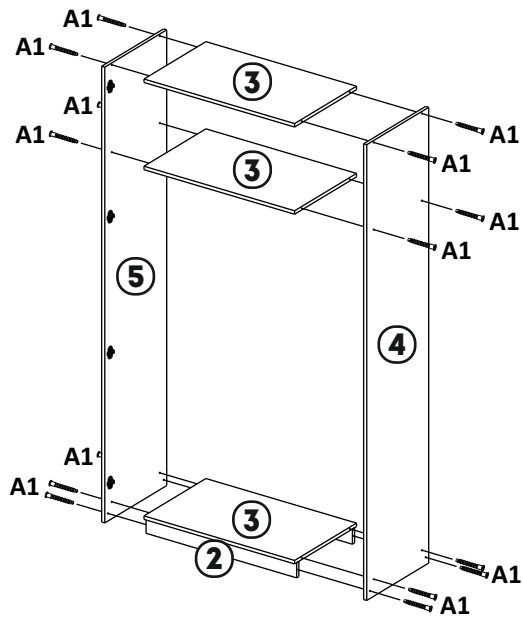
**x16****A2**

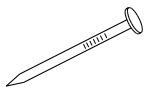
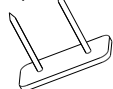
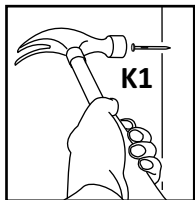
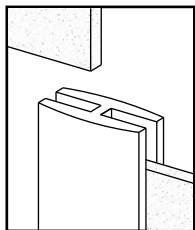
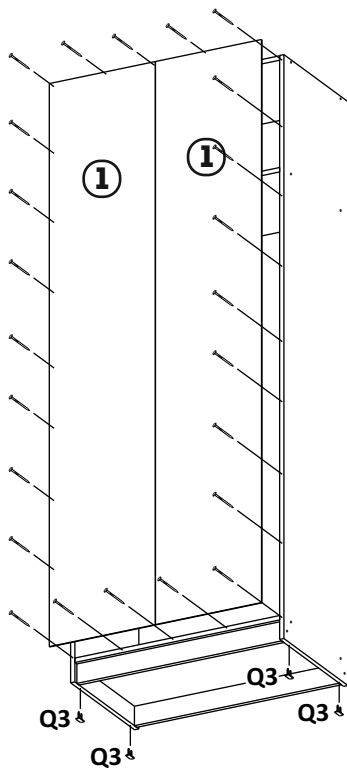
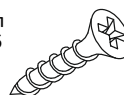
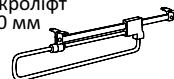
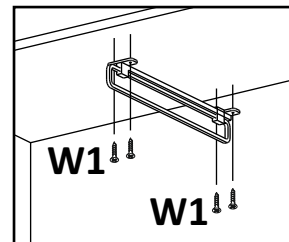
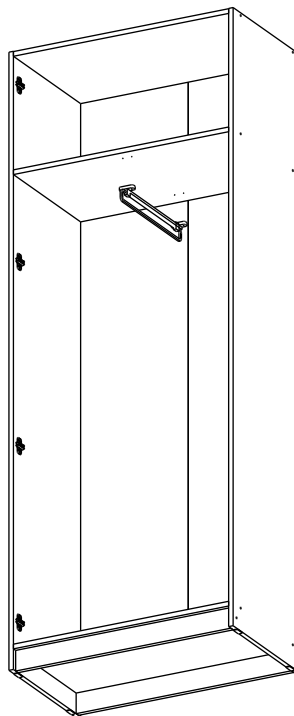
**3**Nail  
Цвях  
1x16**x60****K1**Support-lining  
Цвях опора**x4****Q3****K1****4**Screw  
Шуруп  
3,5x16**x4****W1**Pull-Out Hanger  
Мікроліфт  
400 мм**x1****ML****W1****W1**

# 5

Railing Handle  
Ручка Рейлінг



x2

RR 1

Full Overlay Hinge  
Петля накладна



x8

P5

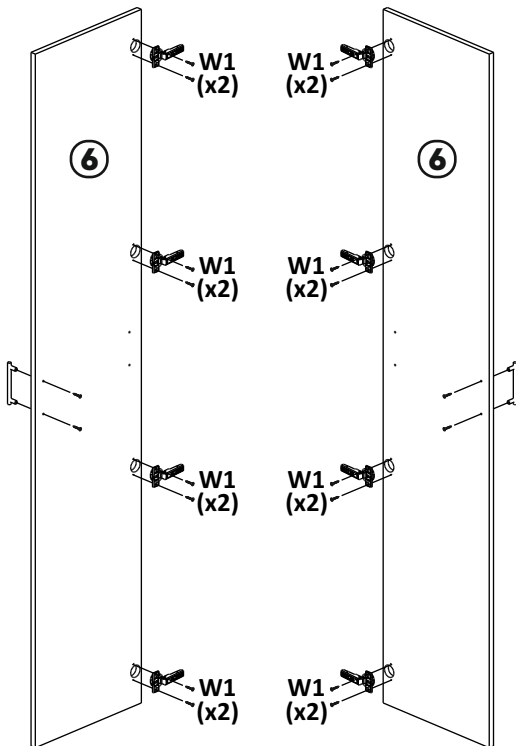

# 6

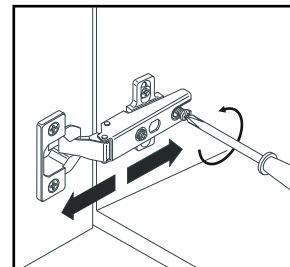
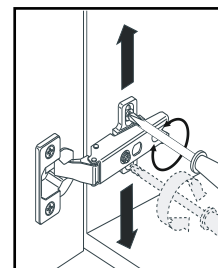
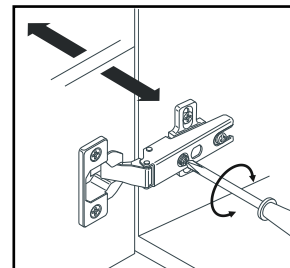
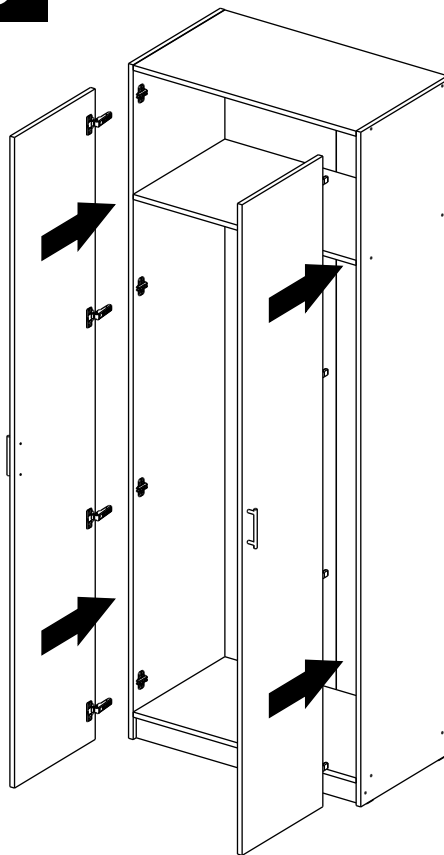

6